

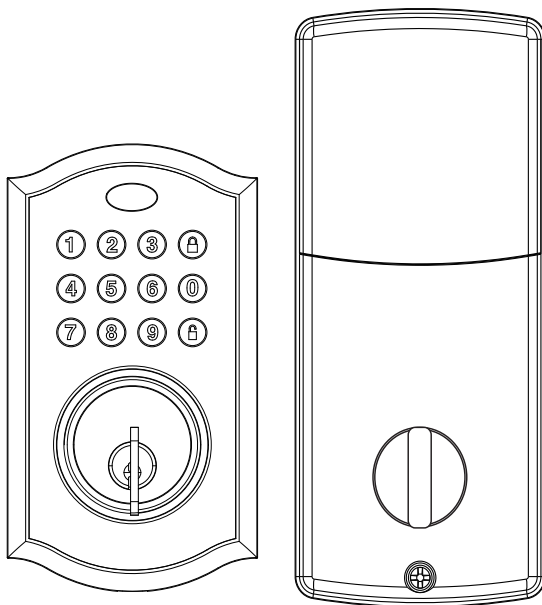

Installation & Operation Guide

Touchscreen Door Lock



INSTALLATION INSTRUCTIONS

| | |
|---|----------|
| Package Contents / Tools Required | Page 1 |
| Prepare Door and Jamb | Page 2 |
| Adjusting Deadbolt Latch Set | Page 3 |
| Installing Deadbolt Latch Set | Page 4 |
| Installing Interior Assembly | Page 5 |
| Installing Exterior Assembly | Page 6 |
| Installing Interior Assembly (Cont.)..... | Page 7-8 |

OPERATION INSTRUCTIONS

| | |
|---|---------|
| Exterior Assembly Overview | Page 9 |
| Locking / Unlocking / Password Programming | Page 10 |
| Fingerprint Management | Page 11 |
| Card / Password Management / Automatic Lock Setting | Page 12 |
| Bluetooth setting / Voice Prompt / Restor Factory Setting | Page 13 |
| Template | Page 14 |

INSTALLATION INSTRUCTIONS

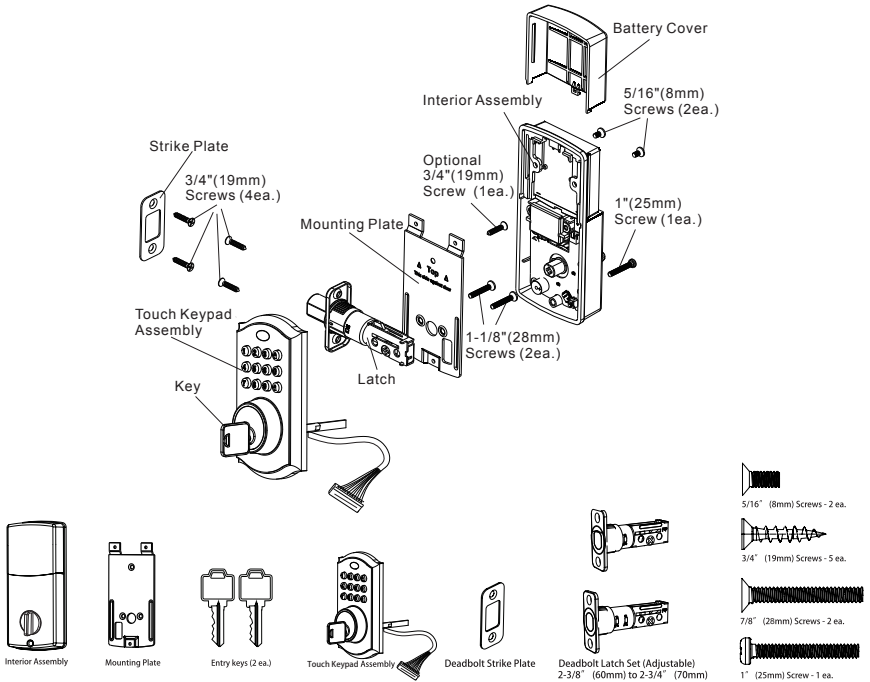

Tools Required

Tools Required for Installation on Pre-drilled Doors:

- Phillips Screwdriver

Tools Required for Installation on Doors That Require Drilling:

- Drill
- Tape Measure
- Pencil
- 2-1/8" (54mm) Drill Hole Saw
- 1" (25mm) Drill
- 1/16" (2mm) Drill
- Chisel
- Hammer
- Phillips Screwdriver

PREPARE DOOR AND JAMB

NOTE: For installation on doors with pre-drilled holes skip to page 4.

1. TEMPLATE

- Cut out template printed on page 14 of this Manual (Figure 1a).
- Fold template and place on door 36" (915mm) from the ground as marked (Figure 1b).

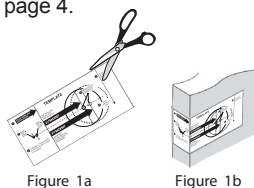

Figure 1a

Figure 1b

2. MARK THE DOOR FOR DRILLING

- Mark center hole on door edge through guide on template for 1" (25mm) latch bolt (Figure 2a).
- Mark center hole on door face through guide on template for 2-3/8" (60mm) or 2-3/4" (70mm) backset (Figure 2b).

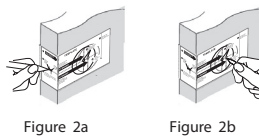

Figure 2a

Figure 2b

3. DRILL AND CHISEL DOOR

- Drill 2-1/8" (54mm) hole through door face as marked for lock set (Figure 3a).
- Drill 1" (25mm) hole in center of door edge for Deadbolt Latch Assembly (Figure 3b).
- Insert Deadbolt Latch Assembly in hole keeping it parallel to face of door. Mark outline and remove latch (Figure 3c).
- Chisel 1/8" (3mm) deep or until latch face is flush with door edge (Figure 3d).

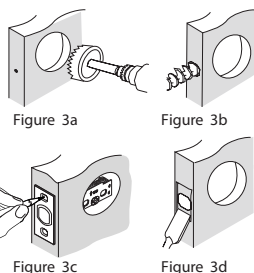

Figure 3a

Figure 3b

Figure 3c

Figure 3d



NOTE: For Drive in Latch, drill hole size indicated on template and press until it is flush with door edge.

4. MARK AND DRILL DOOR JAMB

- Mark center hole on edge of jamb even with the center of the Latch Bolt on door edge. (Figure 4a).
- Drill 1" (25mm) hole 1-3/16" (30mm) deep in door jamb on center mark (Figure 4b).
- Outline outside edges of Strike Plate (Figure 4c).
- Chisel 1/8" (3mm) deep for Strike Plate or until flush (Figure 4d).
- Install Strike Plate using two 3/4" (19mm) screws provided (Figure 4e).

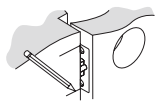

Figure 4a

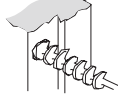

Figure 4b

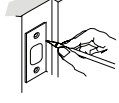

Figure 4c

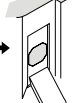

Figure 4d

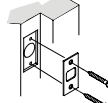

Figure 4e

ADJUSTABLE DEADBOLT LATCH SET

NOTE: Deadbolt Latch Set is shipped with the backset set at 2-3/8" (60mm)
Measure the backset (backset is distance between edge of the door and the center of Lock).

1. TO CONVERT FROM 2-3/8" (60mm) BACKSET TO 2-3/4" (70mm) BACKSET

- Hold latch with numbers facing forward and thumb pressing on the bolt (Figure 1a).
- Rotate the cylinder cover clockwise (Figure 1b).
- Pull and twist the extension plate all the way out (Figure 1c).
- Rotate the cylinder cover counter clockwise so that the marking aligns with the 2-3/4" (70mm) position indicator (Figure 1d).



NOTE: Do not extend Cylindrical Cover past 2-3/4" (70mm)

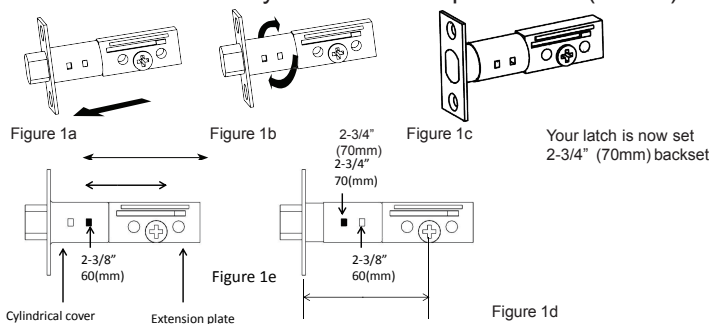

2. TO CONVERT FROM 2-3/4" (70mm) BACKSET TO 2-3/8" (60mm) BACKSET

- Hold latch with numbers facing forward and thumb pressing on the bolt (Figure 2a).
- Rotate the cylinder cover clockwise (Figure 2b).
- Push and twist the extension plate all the way in (Figure 2c).
- Rotate the cylinder cover counter clockwise so that the marking aligns with the 2-3/8" (60mm) position indicator (Figure 2d).

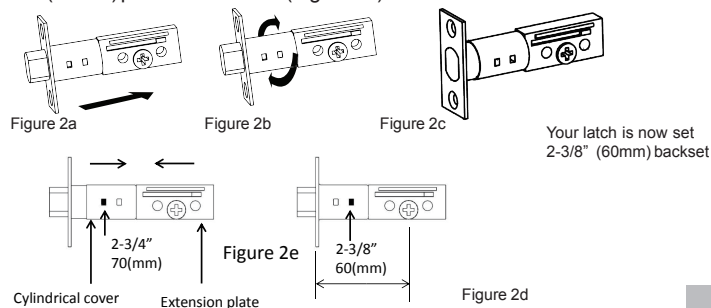

INSTALLING DEADBOLT LATCH SET

3. INSTALLING THE DEADBOLT LATCH SET (need phillips head screwdriver)

- Insert Deadbolt Latch Set into door edge hole with the word "UP" and the arrow on the extension plate facing UP. Cross shaped spindle connector will be at the bottom of the Deadbolt Latch Set (Figure 3a).
- Make sure the face plate sits flush with the door. Do not force the latch into the mortise flush. Chisel out excess material if necessary for a flush fit.
- Using two 3/4" (19mm). screws provided, screw the latch into the door with a hand held screwdriver. **DO NOT OVERTIGHTEN.**

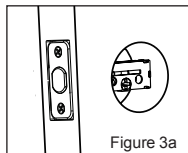
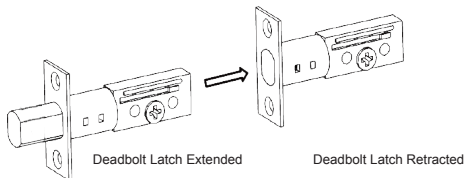

Figure 3a



NOTE: Deadbolt Latch must be Retracted when installing



4. IDENTIFYING YOUR DOOR HANDING

Stand outside the door.

- If the hinges are on the left your door is Left Handed (Figure 4a).
- If the hinges are on the right your door is Right Handed (Figure 4b).

OUT SWING DOOR

Left Handed Door
Hinges are on the left side

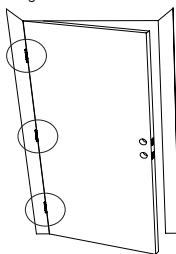

Figure 4a

Right Handed Door
Hinges are on the right side

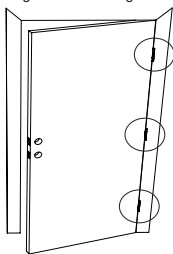

Figure 4b



NOTE: You are standing outside the door

5. UNPACK THE INTERIOR ASSEMBLY

- a. Remove the battery cover by sliding the cover upward.
- b. Locate the screws holding the Mounting Plate to the Interior Assembly. Remove the screws to release the Mounting Plate from the Interior Assembly.

6. SET THE ENTRY SWITCH FOR LEFT OR RIGHT HANDED DOOR

- a. Gently move the switch to "L" for Left Handed Door (Figure 6a).
- b. Gently move the Switch to "R" for Right Handed Door (Figure 6b).

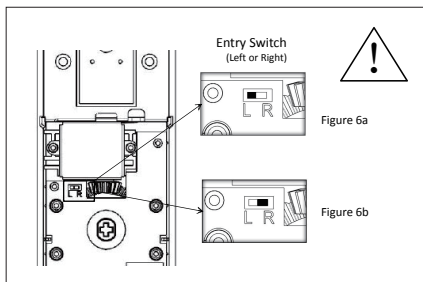

7. SET THE INTERIOR KNOB POSITION FOR LEFT OR RIGHT HAND HINGED DOORS

- a. The interior knob goes in the Horizontal position for Left Handed Doors. (Figure 7a).
- b. The interior knob goes in the Vertical position for Right Handed Doors. (Figure 7b).

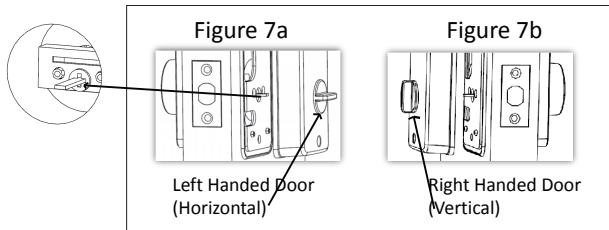

NOTE: Make sure deadbolt Latch is retracted

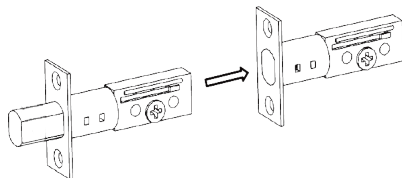

8. INSTALLING THE EXTERIOR ASSEMBLY

Work with the Door Open for easy access.

- Unpack the Exterior Assembly. Use care to not scratch the green circuit board during handling and installation.
- Check that the Rubber Gasket is properly seated on the Exterior Assembly (Figure 8a-b).
- Insert the Exterior Assembly onto the door with the tailpiece going through the Deadbolt Latch Set cross shaped spindle connector in the HORIZONTAL POSITION. Route the Control Wire through the door under the Deadbolt Latch Set.

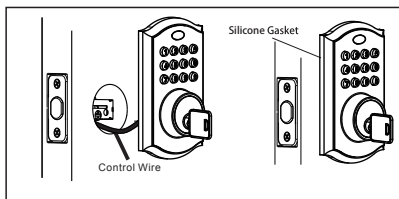

Figure 8a-b

9. SECURING THE EXTERIOR ASSEMBLY TO THE DOOR

- From the side marked "This side against door", route the Control Wire through the rectangular slot in the Mounting Plate (Figure 9a).
- Place Mounting Plate against door with tailpiece passing through the center hole in the three hole set (Figure 9b).
- Secure the Mounting Plate to the Exterior Assembly using two 1-1/8" (28mm) Screws (Figure 9c).
- Hand tighten with a Phillips Screwdriver leaving loosely connected (Figure 9d).
- Check that the Rubber Gasket is properly aligned and correct as necessary (Figure 9e).
- Check vertical alignment of the lock (Figure 9f).
- Tighten securely with a hand held Phillips Screwdriver. **DO NOT OVER TIGHTEN**

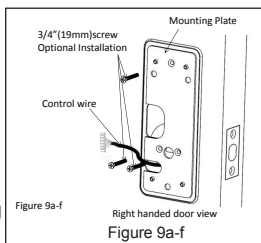

Figure 9a-f

10. OPTIONAL INSTALLATION

- Using a 1/16" (2mm) drill bit, drill a pilot hole in your door using the Mounting Plate upper hole as a guide (Figure 10a).
- Insert one 3/4" (19mm) screw and tighten.

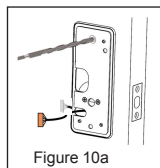

Figure 10a



NOTE: Lock and unlock using the key to see if the Deadbolt Latch is opening and closing easily.

11. ATTACH THE CONTROL WIRE TO THE INTERIOR ASSEMBLY

- Use care to attach the Control Wire male plug to the Interior Assembly female socket connector (Figure 11a).
- Do not force the Control Wire male plug into the Interior Assembly female socket connector (Figure 11b).
- The Control Wire male plug has two alignment tabs on the smooth side of the plug which is the top of the plug (Figure 11c).
- The Control Wire male plug is inserted with the smooth side up into the Interior Assembly female socket connector (Figure 11d).

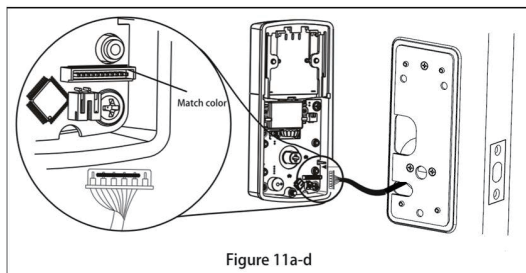

12. ATTACH THE INTERIOR ASSEMBLY TO DOOR

- Position the Interior Assembly over the tailpiece and push the Interior Assembly against the door (Figure 12a).
- Using two 5/16" (8mm) screws and one 1-3/8" (35mm) screw, attach the Interior Assembly to the Mounting Plate. **DO NOT OVER TIGHTEN SCREWS** (Figure 12b).

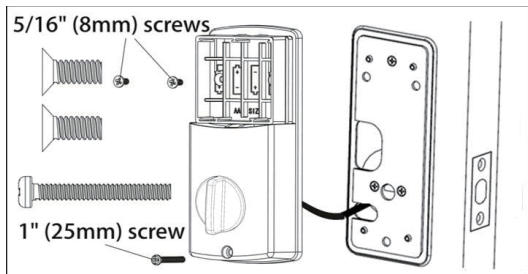

NOTE: Lock and unlock using Interior Knob to see if the latch is opening and closing easily.

13. Installing Batteries

- a. Insert 4 AA high quality Alkaline batteries into the Battery Compartment in the direction noted +/- on the Compartment. The Lock will beep 2 times, the keypad will illuminate blue, and the Clevr button will flash green twice to signify that it has received power (Figure 13a).



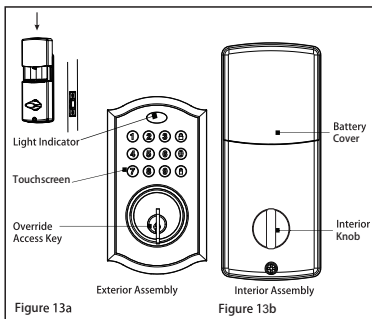

NOTE: Do not touch the Keypad until the blue light turns off. Do not use rechargeable batteries or non-alkaline batteries.

- b. Slide the Battery Cover down into the track on the Interior Assembly to cover the batteries (Figure 13b).



14. Testing Lock

With the Door Open

- a. Test the Lock using the Interior Knob. The bolt should move smoothly.
- b. Test the lock using the Keypad. To lock press  and then press " 123456 "  to unlock.

INSTALLATION OVERVIEW

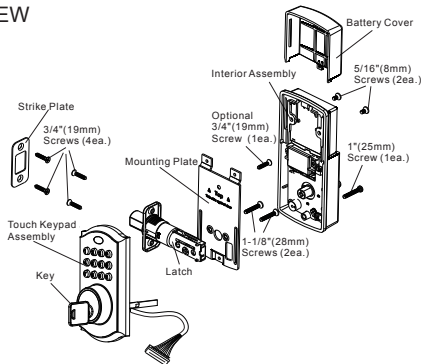

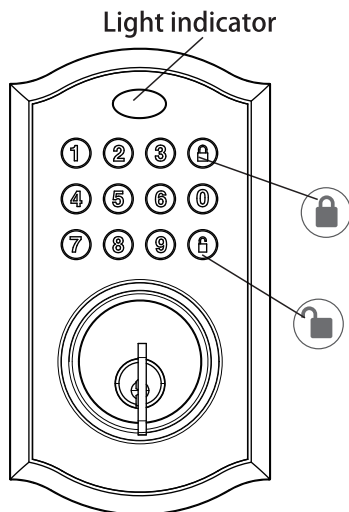

Green

- Indicates Successful Programming Step
 - Indicates Unlocking is Successful
- Red
- Indicates Failed Programming Step
 - Indicates Locking is Successful

Lock button

Lock - Used to lock door

Clear - Used to clear wrong keypad entries

Unlock button





Unlock - Used to unlock door

Programming - Used in programming steps

Batteries (not included)



Electronic lock requires (4) High Quality AA Alkaline batteries. When all 4 batteries are installed in the correct position, hear 2 beeps and the keypad will illuminate blue. DO NOT TOUCH the keypad until the keypad stops illuminating.

Programming Symbols



-  Lock / Clear
-  Unlock / Programming
-  Programming Code
-  User Code (4-9 digits)
-  User ID (01-50, 2 digits)

Factory Settings

The lock comes factory preset with a:

-  Programming code - 123456
-  User code - 123456
-  User ID - 01



Please change the Programming Code  and the User Code  as soon as possible after installation to insure security.

Programming Tips

5 Seconds - Complete all the programming steps in the programming mode within 5 seconds.

Clear - Use the  key to clear entries in case a wrong button is pushed.



TO UNLOCK THE LOCK



Using Keypad: Enter a valid User Code (default code is 123456) and press  and hear 1 beep and lights green.

TO LOCK THE LOCK

Using Keypad: Press  and then hear 2 beeps and lights red.

Changing Programming Code

CHANGE CURRENT OR PRESET PROGRAMMING CODE

Factory default Programming Code  = 123456, this is the master password for your lock. All programming functions require this code. Follow the below sequence to change the Programming Code  to your custom 6 digit combination.





 →  → 4 → new  →  → Re-enter  → 

Hear 1 beep and Light Indicator illuminates green.

Record New and Changed Codes on Programming Record located on Page 16.

Adding User Codes

TO ADD A NEW USER CODE (you can add up to 50 new user codes)

The User Code  must be a 4-9 digit combination. Each User Code  is then linked to a User ID  (which is any number between 01-50) to identify an individual User Code . (User ID  1-9 should be entered as 01-09 so they are 2 digits).

 →  → 1 →  →  →  →  Re-enter  → 

Hear 1 beep and Light Indicator illuminates green.

NOTE: When a NEW USER CODE is set, the default factory code (123456) is deleted for safety.

Record New and Changed Codes on Programming Record located on Page 16.



DELETE ONE EXISTING OR PRESET USER CODE

The unit comes with a factory User ID **ID** = 01 for User Code **UC** = 123456.

IMPORTANT: To delete 1 User Code **UC**, the lock must have more than 1 User Code **UC** in its database.

PC →  → 2 → Existing **ID** →  re-enter **ID** → 

Hear 1 beep and Light Indicator illuminates green.

DELETE ALL USER CODES

IMPORTANT: this will delete the user codes but not the programming code, enter the following.

PC →  → 3 → re-enter **PC** → 

Hear 1 beep and Light Indicator illuminates green.

Automatic Lock Function

SET OR CANCEL AUTO LOCK

You can set the lock to automatically close after each time the lock is opened. Time value range = 3-30 seconds, Default is 10 seconds, enter the following:

Set Auto Lock: **PC** →  → 5 → Time Value → 

Hear 1 beep and Light Indicator illuminates green.

To cancel Auto Lock set the time to 00, enter the following:

Cancel Time Value Auto Lock: **PC** →  → 5 → 00 → 

Hear 1 beep and Light Indicator illuminates green.

Sound On and Off

You can “mute” or turn the “sound on” on your lock by entering the following. (Factory setting is sound on).

PC →  → 6 → 1 or 2 → 

1 = Sound Off
2 = Sound On

Sound Off (1)- Light Indicator illuminates green.

Sound On (2)- Hear 1 beep and Light Indicator illuminates green.





Warning sounds and LED flashes red after 3 incorrect code attempts: Keypad shuts down for 30 seconds.

Bluetooth on and off

PC →  → 7 → 1 beep Bluetooth off

PC →  → 7 → 2 →  beep Bluetooth on

Restore Factory Settings

To reset the lock to the original factory settings including the Programming Code  and all User Codes  remove one battery for 10 seconds. Reinsert the battery and wait for a long and short beep. Press  3 times within 3 seconds. The lock will beep and the light indicator will turn green.

Low Battery Warning

Beeps and LED flashes red for 5 seconds. Replace with good quality alkaline batteries.
Note: Removing batteries does not erase active Programming or User Codes.

Consumer Friendly Message Guide

| | |
|------------------------------------|--|
| Unlock / Valid programming: | 1 long beep and LED illuminates green |
| Lock: | 2 short beeps and LED illuminates red |
| Invalid Programming: | 2 short beeps and LED flashes red twice |
| Low Voltage: | Beeps for 5 seconds (7/9 times depends on operation is unlock/lock) |
| Super Low Voltage: | 4 short beeps and LED flashes red four times |
| 4 Incorrect code entry attempts: | 2 short beeps and LED illuminates red each attempt |
| Power on: | 1 long beep and 1 short beep and LED illuminates green |
| Chip Reset: | 1 long beep and 1 short beep and LED illuminates green (may occur several times or once in a while) |
| Lock Error: | 3 long beeps LED flashes red three times |
| Repeat operation after Lock Error: | 2 short beeps three times LED flashes red six times |

NOTE: When battery is under low voltage, the lock will give the (Low Battery Warning: Beeps and LED flashes red for 5 seconds). During this time your lock can still work. However once the voltage is lower than 4.3V (called Super-Low Voltage), the operation of the locking and unlocking will not work, user must replace batteries immediately.



| Issue | Solution |
|--|---|
| <p>Latch Working Backwards- Lock unlocks when lock button is pushed or locks when unlock button or code is pushed.</p> | <p>Direction switch is set to incorrect setting. Remove the Interior Assembly and move the switch to the opposite direction.</p> <ul style="list-style-type: none">• Check that your switch is set in the correct position Left or Right Handed door. <p><u>If Correct</u></p> <ul style="list-style-type: none">• Rotate Interior Knob and reinstall Interior Assembly. Retest again while holding Interior Assembly in place. |
| <p>Interior Knob will not turn.</p> | <p>Knob or vertical tailpiece is installed in incorrect position. Remove Interior Assembly and reposition the Interior Knob. With the Deadbolt Latch retracted verify that the tailpiece is vertical.</p> |
| <p>Lock will not function electronically.</p> | <ul style="list-style-type: none">• Check that all batteries are fresh high quality Alkaline Batteries.• Check for proper polarity (+ -) of all batteries.• Check that the Control Wire is attached to the Interior Assembly. |
| <p>Lock gives error signal when opening or locking and Deadbolt Latch will not extend or retract completely when door is closed.</p> | <p>Unlock door using Key or Interior Knob. While door is open, check that the Deadbolt Latch operates smoothly. Check for proper alignment of the strike plate, adjust as needed to assure there is no binding against the Deadbolt Latch.</p> |
| <p>Deadbolt Latch is sticking.</p> | <p>Installation screws of the lock may be too tight and have to be loosened.</p> <ul style="list-style-type: none">• Remove Interior Assembly.• Slightly loosen the Mounting Plate screws.• Lock and unlock using the Key.• Reattach Control Wire and Interior Assembly. |

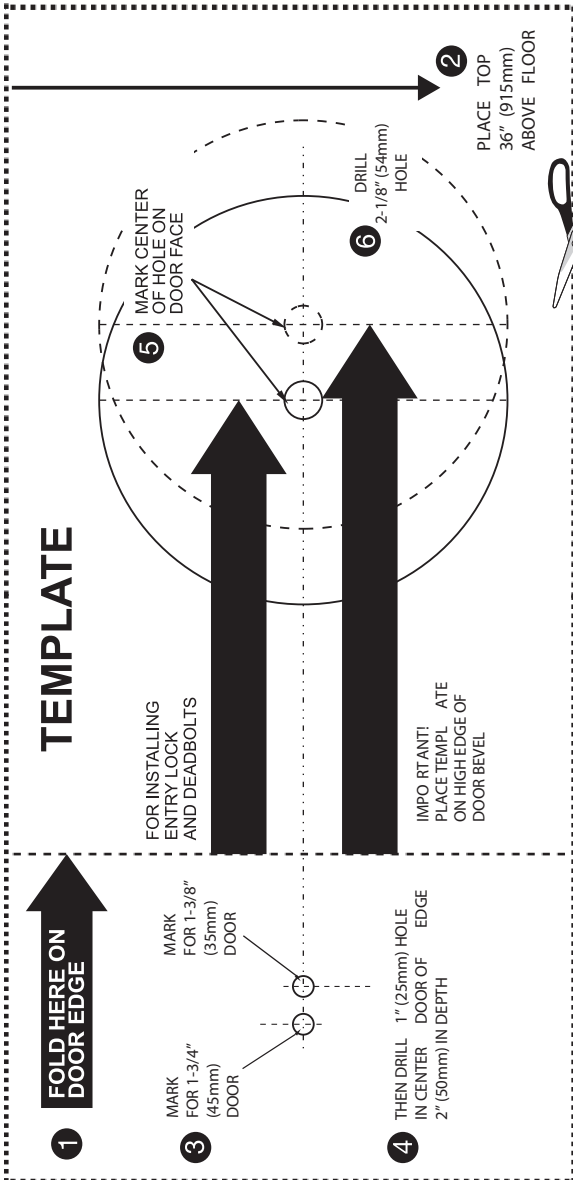

TEMPLATE

1

FOLD HERE ON DOOR EDGE

MARK FOR 1-3/4" (45mm) DOOR

MARK FOR 1-3/8" (35mm) DOOR

4

THEN DRILL 1" (25mm) HOLE IN CENTER DOOR OF EDGE 2" (50mm) IN DEPTH

5 MARK CENTER OF HOLE ON DOOR FACE

6

DRILL 2-1/8" (54mm) HOLE

2

PLACE TOP 36" (915mm) ABOVE FLOOR



IMPORTANT! PLACE TEMPLATE ON HIGH EDGE OF DOOR BEVEL

FOR INSTALLING ENTRY LOCK AND DEADBOLTS



BACK OF TEMPLATE